

On-Grid PV Inverter

Installation and Operation Manual



www.aforeenergy.com

Version: 03.610100007100

Afore

Afore New Energy Technology (Shanghai) Co., Ltd.

T 86-21-54326236 F +86-21-54326136 E info@aforeenergy.com

Ad Building 7, No.333 Wanfang Rd, Minhang District, Shanghai, China. 201112

Afore

Afore New Energy Technology (Shanghai) Co., Ltd.

Contents

1. About This Manual	1
1.1 Scope of Validity	1
1.2 Target Group	1
1.3 System Diagram	1
2. Safety & Symbols	2
2.1 Safety Precautions	2
2.2 Explanations of Symbols	3
3. Installation	4
3.1 Pre-installation	4
3.1.1 Unpacking & Package List	4
3.1.2 Exterior Objects	5
3.1.3 Mounting Location	7
3.2 Mounting	8
4. Electrical Connection.	9
4.1 PV Connection	9
4.2 Grid Connection	11
4.3 Earth Connection	14
4.4 Communication Connection	15
5. Operation	18
5.1 Control Panel	18
5.2 Menu Structure	19
5.3 Setting	20
5.3.1 Startup	20
5.3.2 Voltage Range	21
5.3.3 Frequency Range	21
6. Commissioning	22
7. Start-up & Shut Down	22
7.1 Start-up	22
7.2 Shut down	23
7.3 Restart	23
8. Maintenance&Trouble Shooting	23
8.1 Maintenance	23
8.2 Trouble Shooting	23
9. Specifications	27

1. About This Manual

1.1 Scope of Validity

This manual describes the installation, commissioning, operation and maintenance of the following on-grid PV inverters produced by Afore New Energy:

Single-Phase(Two MPPT Tracker)

HNS7000TL HNS8000TL HNS9000TL HNS10000TL

Please keep this manual stored carefully and accessible at any time.

1.2 Target Group

This manual is for qualified personnel. The tasks described in this manual must only be performed by qualified personnel.

1.3 System Diagram

The typical connection diagram for the entire PV system is on-grid.

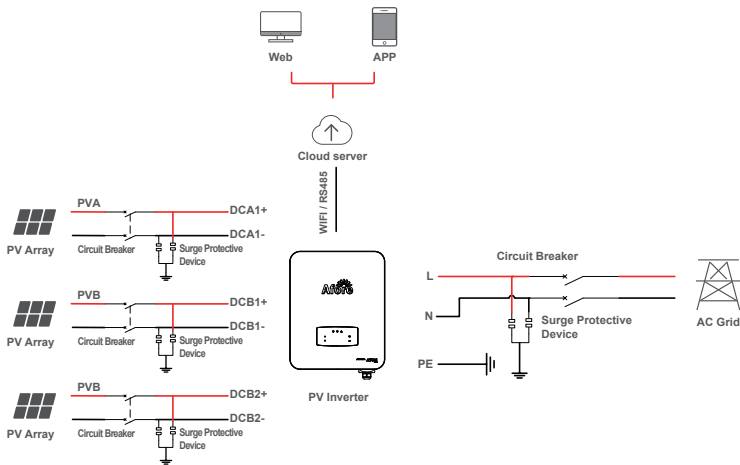

Circuit Breaker and Surge Protector Recommendation:

Type	Max AC Current [A]	Rated current of AC breaker[A]
Single-Phase(Two MPPT Trackers)		
HNS7000TL	33.6	63A
HNS8000TL	38.3	63A
HNS9000TL	45	100A
HNS10000TL	50	100A

SPD: Lightning protection system, refer to the following options:

- AC side, nominal discharge current 20KA, second grade lightning protection, protection voltage AC 2.5KV.
- DC side, nominal discharge current 20KA, second grade lightning protection, protection voltage DC 3.2KV.



Note:

The Inverter can be only connected to low-voltage grid. (220 / 230 / 240Vac,50 / 60Hz).

2. Safety & Symbols

2.1 Safety Precautions

1. All work on the inverter must be carried out by qualified electricians. And ensure that children cannot access to the inverter.
2. The PV generator and inverter must be connected to the ground separately in order to reach maximum protection for property and persons.
3. Do not touch cover until five minutes after disconnecting all sources of supply. This is because the charge stored in capacitors may result a risk of electric shock.
4. The enclosure of Inverter can become hot during operation. To reduce the risk of injury, do not touch the cover, heat sink at the back of the PV-Inverter or nearby surfaces while Inverter is operating.

5. Do not use the inverter for other purposes which not described in this manual.
6. Both the inverter and associated transport packaging are mainly made of recyclable raw materials. Please ensure that the used device and any relevant accessories are disposed of in accordance with applicable regulations.
7. Packed with EPE foam and carton, the inverter should be placed upwards and handled with care in delivery. Pay attention to waterproof.
8. Alternative uses, modifications to the inverter not recommended. The installation of components not authorized by Afore New Energy will void the warranty claims.

2.2 Explanations of Symbols

Afore inverter strictly comply with relevant safety standards. Please read and follow all the instructions and cautions during installation, operation and maintenance.



Danger of electric shock

The inverter contains fatal DC and AC power. All work on the inverter must be carried out by qualified personnel only.



Beware of hot surface

The inverter's housing may reach uncomfortably hot 60°C (140°F) under high power operation. Do not touch the inverter enclosure when operation.



Residual power discharge

Do not open the inverter cover until 5 minutes after disconnection both DC and AC power supply.



Important notes

Read all instructions carefully. Failure to follow these instructions, warnings and precautions may lead to device malfunction or damage.



Do not dispose of this device with the normal domestic waste.



Without transformer

This inverter does not use transformer for the isolation function.



CE mark

The inverter complies with the requirements of the applicable CE guidelines.



Refer to manual before service.

3. Installation

3.1 Pre-installation

3.1.1 Unpacking & Package List

Unpacking

On receiving the inverter, please check to make sure the packing and all components are not missing or damaged. Please contact your dealer directly for supports if there is any damage or missing components.

Package List

Open the package, please check the packing list shown as below.

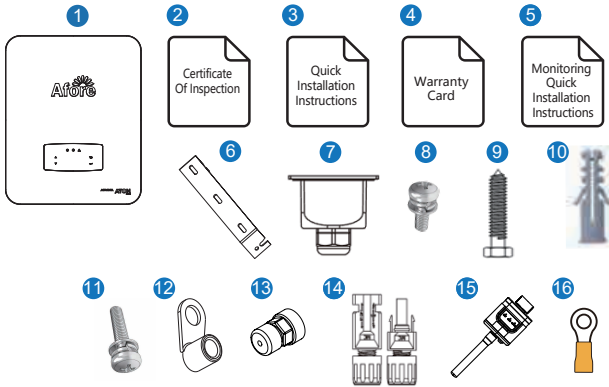

No.	Qty	Items	No.	Qty	Items
1	1	Solar Inverter	9	3	Mounting Bracket Screw
2	1	Certificate Of Inspection	10	3	Plastic Expansion Tube
3	1	Quick Installation Instructions	11	1	Security Screw
4	1	Warranty Card	12	3	AC Wearing Terminal
5	1	Monitoring Quick Installation Instructions	13	1	Zero-Injection Connector(Optional)
6	1	Wall Mounting Bracket	14	3/4	DC Connector sets
7	1	Waterproof Cover	15	1	Monitor Module
8	4	Wiring Cover Screw	16	1	Grounding Terminal



Note:

DC connectors NO.: 7-8kW 3 pairs, 9-10kW 4 pairs.

3.1.2 Exterior Objects

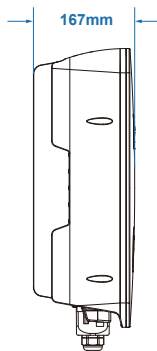
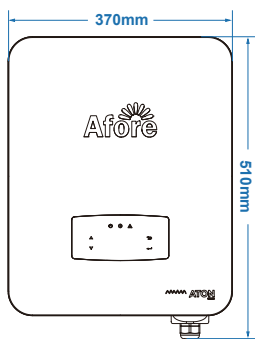

HNS7000-8000TL

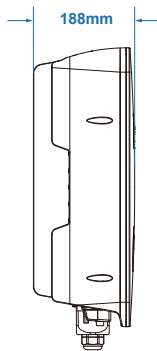
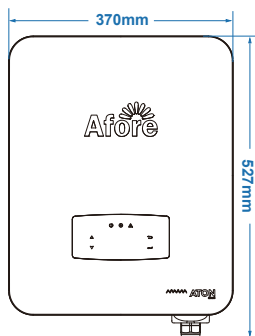

HNS9000-10000TL

Inverter Terminals

HNS7000-8000TL

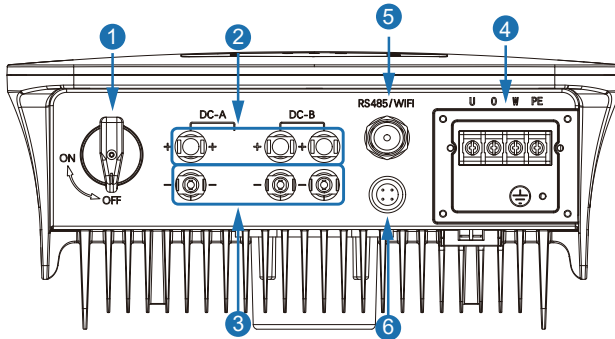

HNS9000-10000TL

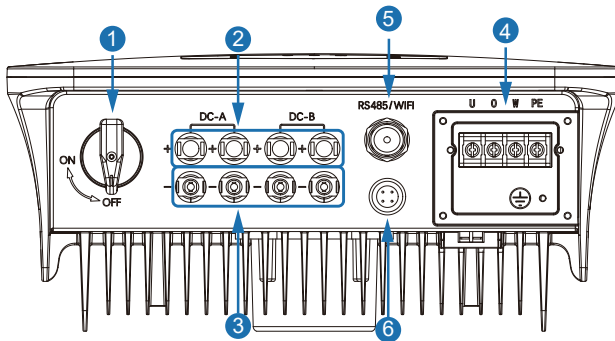

No. Items

- | | |
|---|------------------------------------|
| 1 | DC Switch |
| 2 | DC Connectors (+) For PV Strings |
| 3 | DC Connectors (-) For PV Strings |
| 4 | AC Connector |
| 5 | Zero-Injection (Optional) |
| 6 | Monitor Module |

3.1.3 Mounting Location

The inverters are designed for indoor and outdoor installation (IP65), to increase the safety, performance and lifespan of the inverter, please select the mounting location carefully based on the following rules:

- The inverter should be installed on a solid surface, far from flammable or corrosion materials, where is suitable for inverter's weight and dimensions.
- The ambient temperature should be within $-25^{\circ}\text{C} \sim 60^{\circ}\text{C}$ (between -13°F and 140°F).
- The installation of inverter should be protected under shelter. Do not expose the inverter to direct sunlight, water, rain, snow, spray lightning, etc.

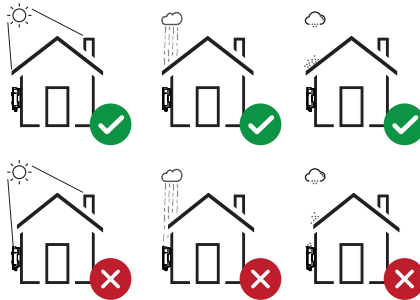

- The inverter should be installed vertically on the wall, or lean back on plane with a limited tilted angle. Please refer to below picture.

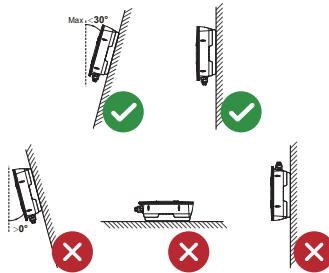

- Keep enough space for sufficient heat dissipation, convenient operation and maintenance.

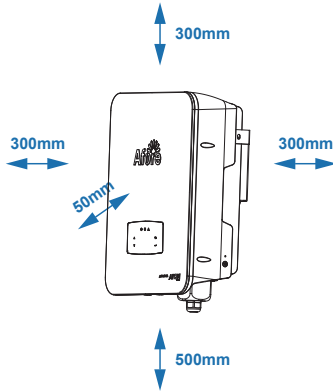

3.2 Mounting

Step 1

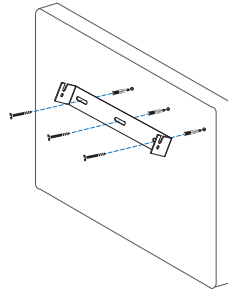
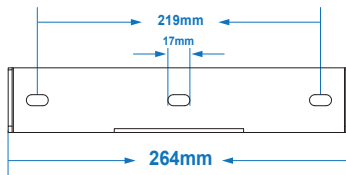

Step 2

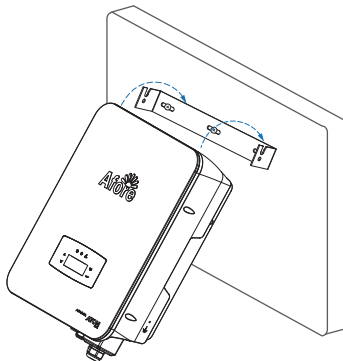

Step 3

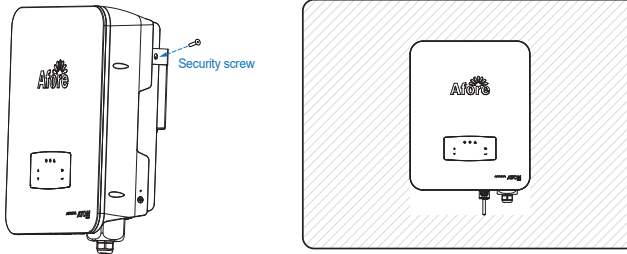

4. Electrical Connection

4.1 PV Connection

HNS7000TL and HNS8000TL inverters have dual MPPT channels, channel A includes 1 PV string input, and channel B includes 2 PV string inputs. For the best results, please ensure that each pair of photovoltaic input terminals is connected to a photovoltaic string separately. Otherwise, the inverter will trigger the voltage or current protection automatically. Please make sure below requirements are followed:

- The open-circuit voltage and short-circuit current of PV string should not exceed the reasonable range of the inverters.
- The isolation resistance between PV string and ground must exceed 10 k Ω .
- The polarity of PV strings are correct.
- Use the DC plugs in the accessory.
- The lightning protector should be equipped between PV string and inverter.
- Disconnect all of the PV (DC) switch during wiring.

**Warning:**

The fatal high voltage may on the DC side, please comply with electric safety when connecting.

Please make sure the cable connected in correct polarity with inverter, otherwise inverter could be damaged.

Step 1

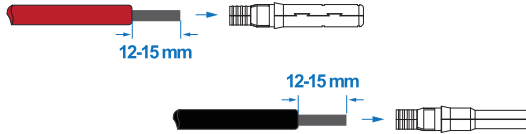

Note:
 PV cable suggestion
 Cross-section
 $\geq 4\text{mm}^2$

Step 2

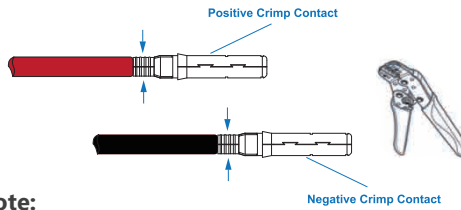

Note:
 The cable should be tightly
 connected by the crimping
 pliers.

Step 3

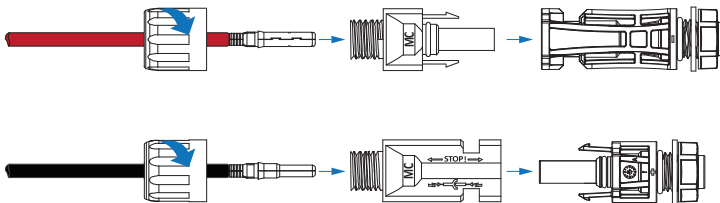

Note:
 A "click" will be heard when the connectors are assembled correctly.

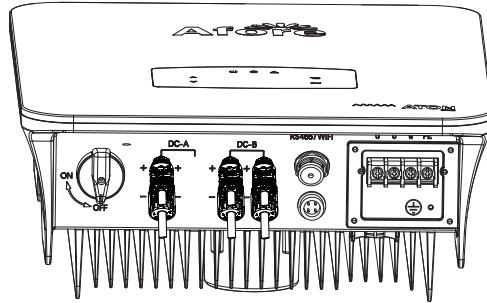
**Note:**

PV string suggestion: HNS7000-8000TL connect 3 PV strings,
HNS9000-10000TL connect 4 PV strings.

4.2 Grid Connection

The on-grid PV inverters work with grid (220/230/240 Vac, 50/60 Hz).

The external AC switch should be installed between inverter and grid to isolate from grid. Please make sure below requirements are followed before connecting AC cable to the inverter.

- The AC (grid) voltage should not exceed the reasonable range of the inverters.
- The phase-line from AC distribution box are correctly connected.
- Use the AC plugs in the accessory.
- The surge protector should be equipped between grid and inverter.
- Disconnect the AC (grid) switch during wiring.

**Warning:**

The fatal high voltage may on the AC side, please comply with electric safety when connecting.
Please make sure the right line of AC grid connected with inverter, otherwise inverter could be damaged.

Step 1

Like picture shown below, pass the AC cable (cross section for 7-8kW $\geq 6\text{mm}^2$ (copper) / 9-10kW $\geq 10\text{mm}^2$ (copper) or 16mm^2 (aluminum)) through the junction box with a stripped length of $10\pm 0.5\text{mm}$, use crimping pliers to crimp the stripped wire harness to the terminal, wrap the joint position with insulation tape.

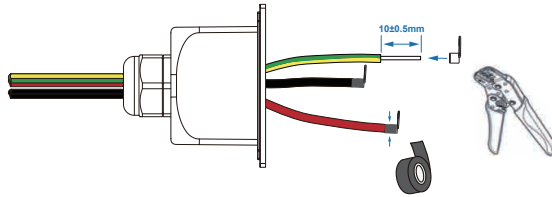

Note:

The wiring terminals should be wrapped with insulation tape, otherwise it will cause a short circuit and damage the inverter.

Step 2

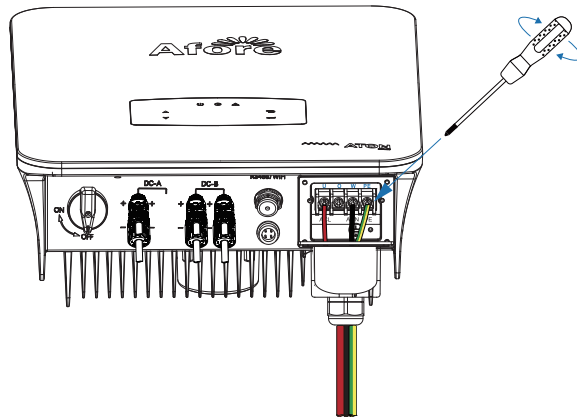

U=ACL=Live line

W=ACN=Neutral line

Unscrew the row of screws,
insert the wire harness into the U,W,PE caps one by one,
and tighten the screws.

Step 3

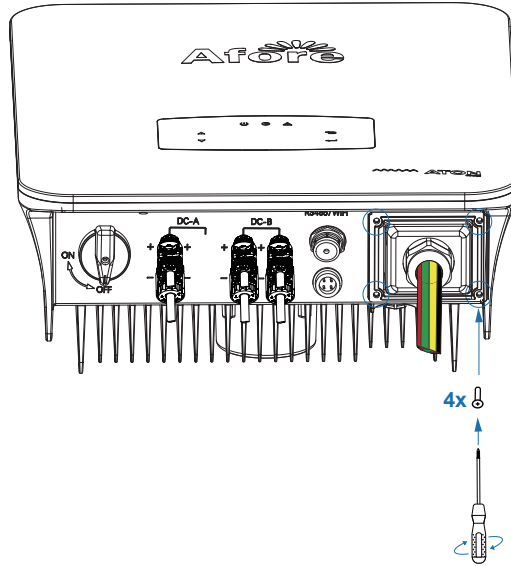

Fix the junction box with the wiring cover screws in the accessories, and tighten the waterproof connector.

4.3 Earth Connection

The user must connect a protective earth (PE) terminal to prevent electric shock. And make sure this PE terminal is properly grounded.

Step 1

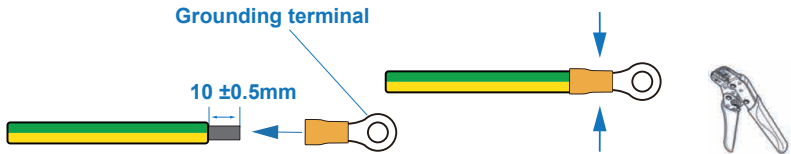

Note:
copper cable or aluminum cable Cable diameter $\geq 6\text{mm}^2$

Step 2

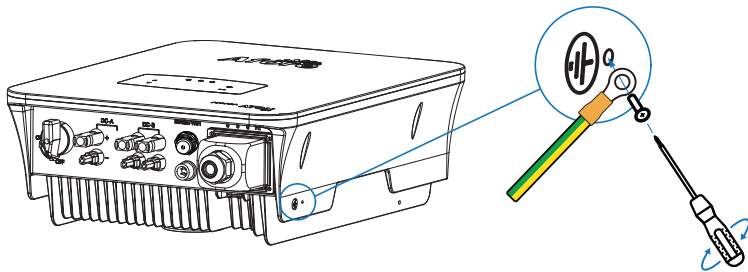

Fix the yellow-green PE wire to the ground hole on the lower right side of the inverter with screws, make sure that the PE terminal is properly grounded.

4.4 Communication Connection

The monitoring module could transmit the data to the cloud server, and display the data on the PC, tablet and smart-phone.

Install the WIFI / Ethernet / GPRS / RS485 Communication

WIFI / Ethernet / GPRS / RS485 communication is applicable to the inverter. Please refer to "Communication Configuration Instruction" for detailed instruction.

Step 1

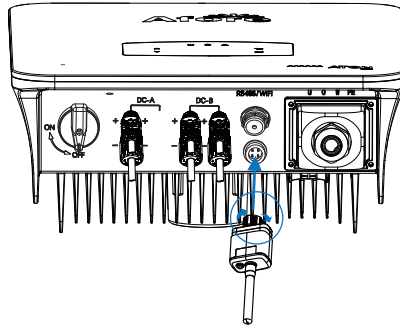

Step 2

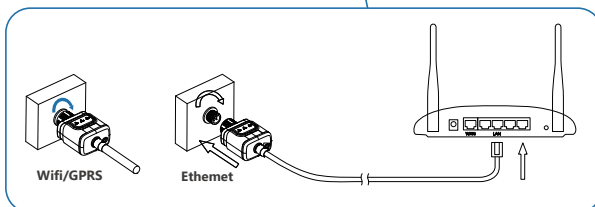
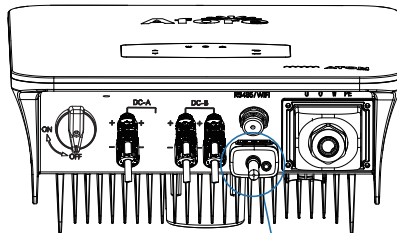

Zero-injection Smart Meter (Optional)

Smart meter is an intelligent control equipment which is used for on-grid inverters. Its main function is to measure the forward and reverse power on the grid-connected side, and transmit data to the inverter through RS485 communication to ensure that the power of the inverter is less than or equal to the user's home load, and no current flows into the grid.

Step 1

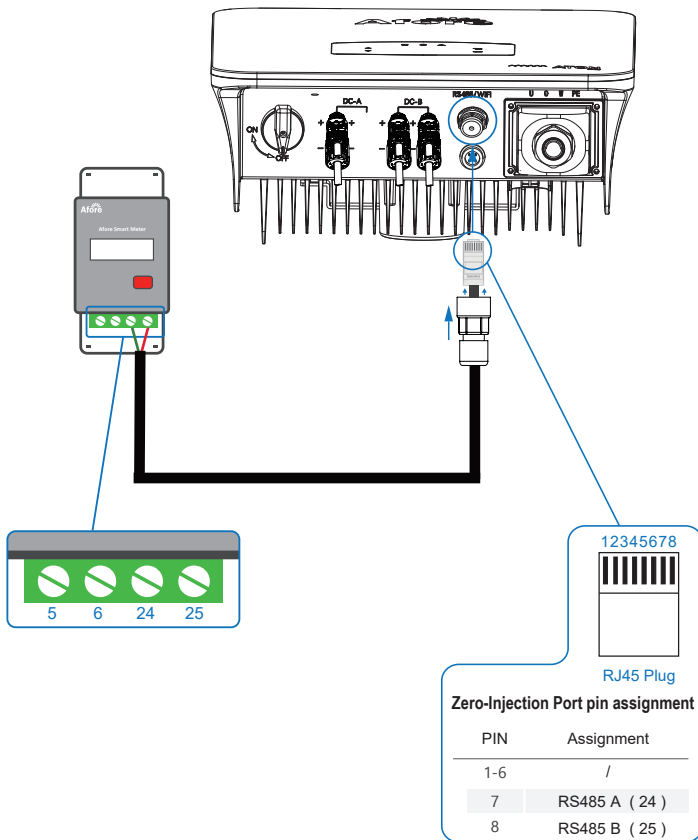

Step 2

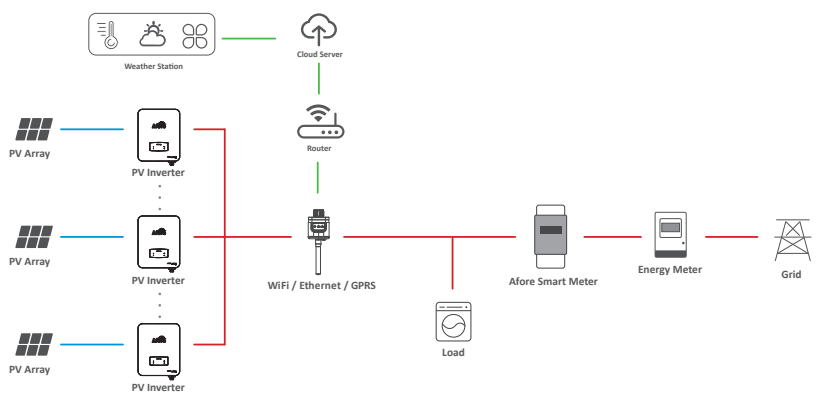
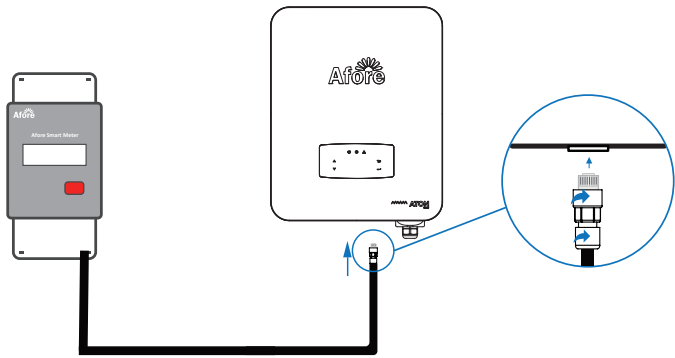

Note:  The Inverter could be connected in parallel with Smart Meter, make sure the total load power not exceed Smart Meter's limitation.

5. Operation

5.1 Control Panel

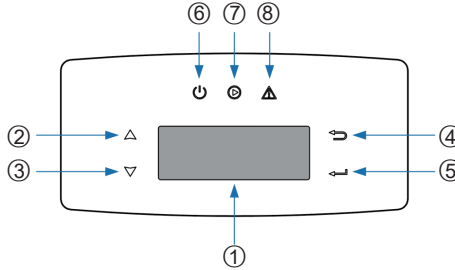

No.	Items	No.	Items
1	LCD Display	5	ENT Touch Button
2	UP Touch Button	6	POWER LED Indicator
3	DOWN Touch Button	7	GRID LED Indicator
4	ESC Touch Button	8	FAULT LED Indicator

Sign	Power	Color	Explanation
POWER	On	Green	The inverter can detect DC power
	Off		No DC power or low DC power
GRID	On	Green	The inverter is supplying power
	Off		The inverter has stopped to supply power
FAULT	On	Red	inverter the fails
	Off		inverter no fault

5.2 Menu Structure

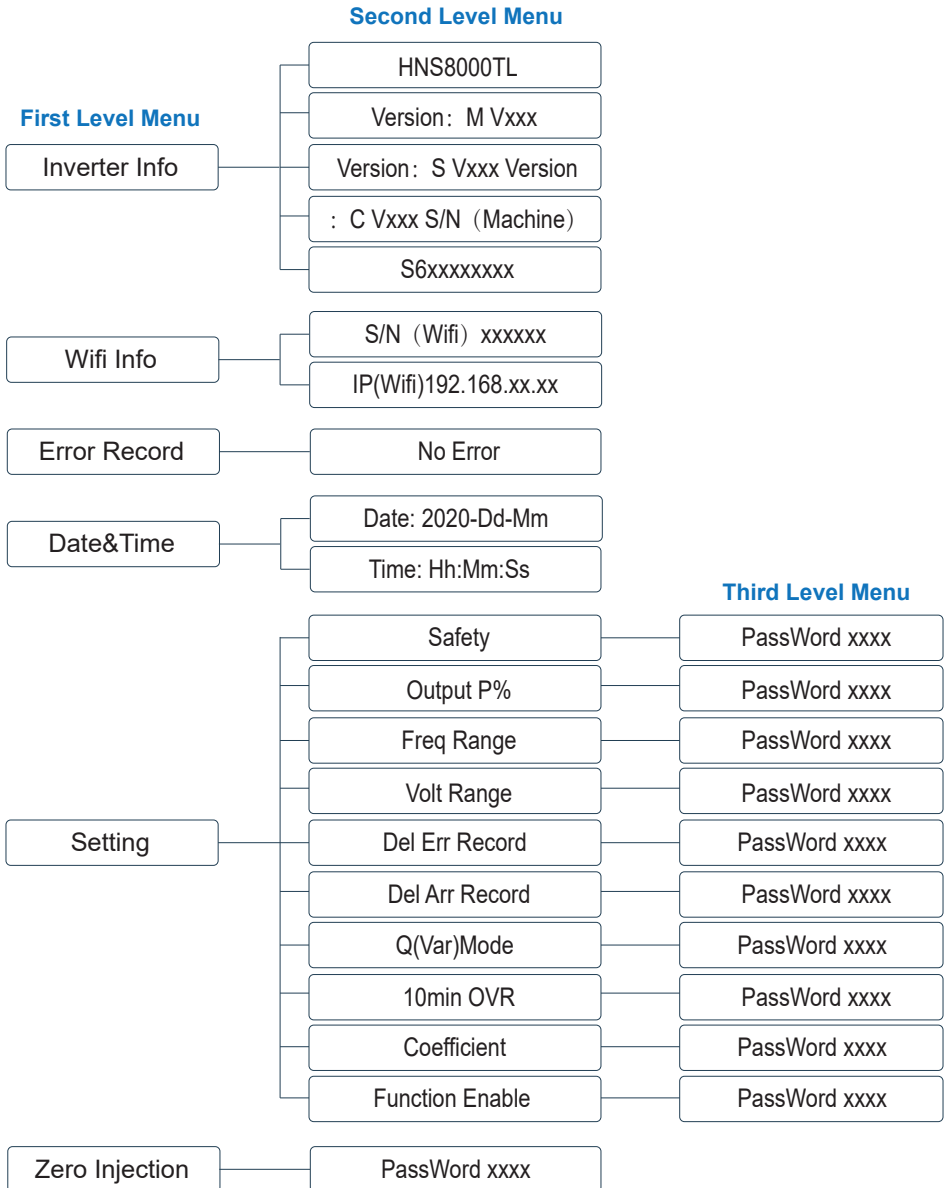

Explanation of LCD Display Content

Nouns	Explanation
Inverter Info	Display the serial number and firmware version of inverter
Error Record	Check the error list of inverter including date and time
Wifi Info	Display the WIFI serial number and assigned IP address
Date & Time	Set date and time of the inverter
Setting	Set the protection parameters of inverter
Zero Injection	Countercurrent

5.3 Setting

5.3.1 Startup

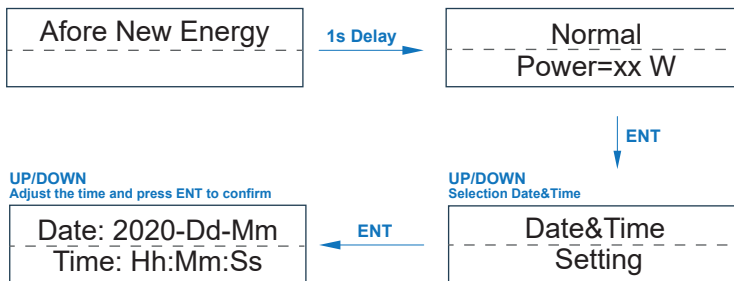

5.3.2 Voltage Range

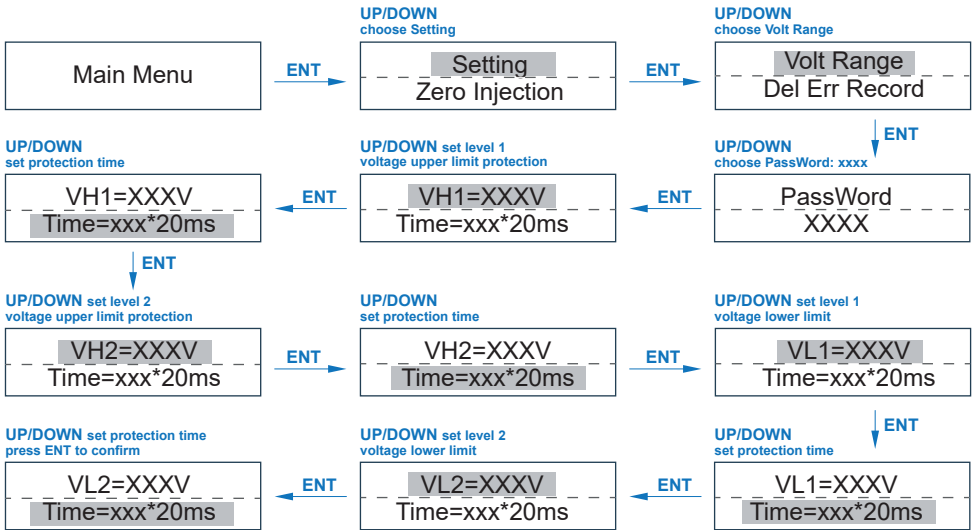

5.3.3 Frequency Range

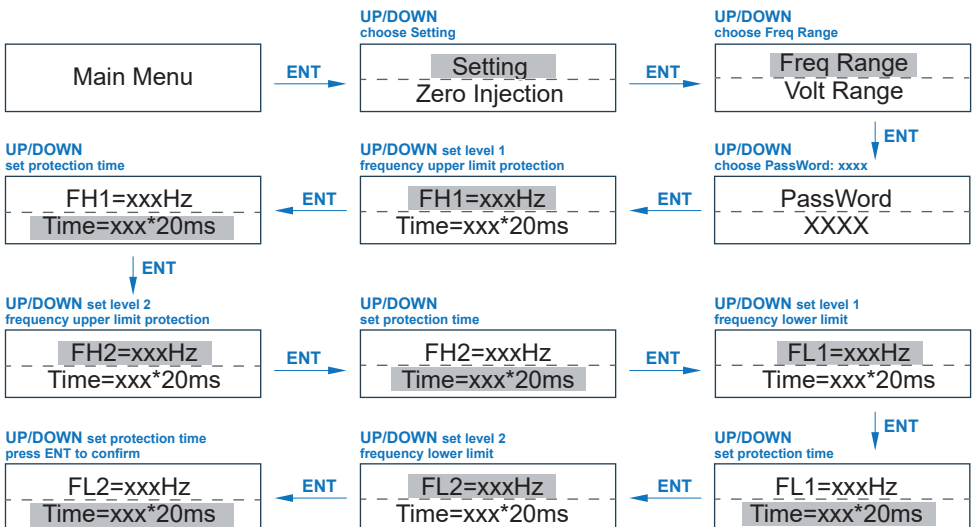

6. Commissioning

Before starting up commissioning at site, please make sure below procedures and requirements are fully meet.

- Mounting location is meet the requirements.
- All of the electrical wiring is firmly connected, including PV wiring, Grid wiring and Earth wiring.
- The inverter setting has been finished accordingly to local standards or regulations.

Commissioning Procedures

- Turn on the AC switch between inverter output and the public grid;
- Turn on the DC switch on the inverter;
- Turn on the PV switch of the system.

7. Start-up & Shut Down

Please check the following requirements before testing:

- Installation location is suitable according to Chapter 3.1.3.
- All electrical wires are connected tightly, including PV modules, AC side, Earth Line.
- Inverters should be set according to the required local grid standard.
- More information please contact with Afore or distributors.

7.1 Start-up

- Turn on the AC switch between the inverter and the public grid.
- Turn on the DC switch between PV panels and the inverter (if any).
- Turn on the DC switch on the inverter.

Inverter will enter into standby mode, and the LCD screen lights up and show contents , and then complete the first setting of the inverter according to 5.3.1. The LED will be lighted up after the inverter enter into running states.

7.2 Shut down

- Turn off the DC switch on the inverter.
- Turn off the DC switch between PV panels and the inverter (if any).
- Close the AC switch between the inverter and the public grid.

**Note:**

The inverter will be operable after minimum 5 minutes.

7.3 Restart

- Shut down the inverter according to Chapter 7.2.
- Start-up the inverter according to Chapter 7.1.

8. Maintenance&Trouble Shooting

8.1 Maintenance

Periodically maintenance are necessary, please follow steps as below.

PV connection: twice a year

AC connection : twice a year

Earth connection: twice a year

Heat sink: clean with dry towel once a year.

8.2 Trouble Shooting

Fault messages will be displayed when fault occurs, please according to trouble- shooting table find related solutions.

Trouble-Shooting List

Type of Fault	Name	Description	Recommend Solution
PV Fault	Isolation Fault	The impedance between ground and PV (+) & PV (-) is too low, beyond the reasonable range.	<ul style="list-style-type: none"> • Check whether the battery and wiring are immersed in water and whether the insulation layer is damaged, and then make corrections. • If the fault occurs continuously and frequently, please ask help for local distributors.
	PV Volt Low	The DC input voltage from PV strings is below the minimum reasonable value.	<ul style="list-style-type: none"> • Reconfigure the PV strings by increasing the number of PV strings to increase DC input voltage. • Contact local distributors for suggestions and solutions.
	PV Volt High	The DC input voltage from PV strings is exceeding the maximum reasonable value.	<ul style="list-style-type: none"> • Reconfigure the PV strings by reducing the number of PV strings to decrease DC input voltage. • Contact local distributors for suggestions and solutions.
	PV1 Over Current	PV1 current is too high, protection is triggered.	<ul style="list-style-type: none"> • Power off, then restart (Ref. Chapter6) • If fault still occurs continuously and frequently, please ask help for local distributors.
	PV2 Over Current	PV2 current is too high, protection is triggered.	
Grid Fault	Island Fault	The public grid is outage or the grid is disconnected to the inverter.	<ul style="list-style-type: none"> • The fault will disappear automatically when the public grid go back to normal. • Contact the local distributor or grid company to adjust the voltage protection parameters.
	10min Over Volt	The 10-minute average value of the grid voltage is abnormal and beyond the protection range.	<ul style="list-style-type: none"> • Power off, then restart (Ref. Chapter6) • If fault still occurs continuously and frequently, please ask help for local distributors.
	Grid Volt Fault	Grid voltage is abnormal, beyond the protection range.	<ul style="list-style-type: none"> • The fault will disappear automatically when the grid voltage is back to normal. • If fault still occurs continuously and frequently, please ask help for local distributors.
	Grid Freq Fault	Grid frequency is abnormal, beyond the protection range.	<ul style="list-style-type: none"> • The fault will disappear automatically when the grid frequency is back to normal. • If fault still occurs continuously and frequently, please ask help for local distributors.

Type of Fault	Name	Description	Recommend Solution
DC Fault	Bus Low Fault	When inverter is running, bus voltage is lower than the normal value beyond the protection range.	<ul style="list-style-type: none"> • Power off, then restart (Ref. Chapter6) • If fault still occurs continuously and frequently, please ask help for local distributors.
	Bus High Volt	Bus voltage is too high and beyond the protection range.	
	Bus Unbalance	Bus voltage unbalanced, beyond the protection range.	
	DC Offset Fault	The DC component of grid-connected current is too high that beyond the reasonable range.	
AC Fault	Ground I Fault	The ground current of AC output is too high that beyond the reasonable range.	<ul style="list-style-type: none"> • Check whether the PV panel has good ground insulation and the ground wire connection is good, if not, repair them. • Power off, then restart (Ref. Chapter6) • If fault still occurs continuously and frequently, please ask help for local distributors.
	Relay Fault	The relay could not be disconnected or connected.	
	Inv Over Current	Inverter current is high that beyond the reasonable range.	
System Fault	Over Temperature	The temperature of the installation environment is too high or too low, beyond the reasonable range.	<ul style="list-style-type: none"> • Improve or change the installation environment to adjust the inverter installation environment temperature to normal range. • Power off, then restart (Ref. Chapter6) • If fault still occurs continuously and frequently, please ask help for local distributors.
		The temperature of the cooling device is high or low that beyond the protection range.	
		The temperature of the CPU is high that beyond the protection range.	
	Auto Test Fail	Automatic test failed.	
No Utility	No continuous utility		

Type of Fault	Name	Description	Recommend Solution
System Fault	Grid Volt AD	Grid voltage AD value deviation is too high, beyond the protection range.	<ul style="list-style-type: none"> • Power off, then restart (Ref. Chapter6) • If fault still occurs continuously and frequently, please ask help for local distributors.
	Self Lock	Inverter is locked at the waiting interface.	
	Consistent Fault	The detection results of the two CPUs for the same voltage and frequency are different.	
	Device Fault	Grounding is abnormal or the ground wire is disconnected.	<ul style="list-style-type: none"> • Check whether the ground wire of the inverter is properly connected and the ground impedance is too high, if it is, make corrections. • Power off, then restart (Ref. Chapter6) • If fault still occurs continuously and frequently, please ask help for local distributors.distributors.
Inner Warning	Fan Fault	The fan can not work when is started up.	<ul style="list-style-type: none"> • Check if there is objects which blocking the fan rotation and remove it.
	Eeprom Fault	Eeprom abnormal	<ul style="list-style-type: none"> • Power off, then restart (Ref. Chapter6) • If fault still occurs continuously and frequently, please ask help for local distributors.
	Communication Lose	CPU to Flash abnormal	
		CPU to Eeprom abnormal	
		Main CPU to auxiliary abnormal	
Main CPU to HMI abnormal			

9. Specifications

PV Input Data	HNS7000TL	HNS8000TL	HNS9000TL	HNS10000TL
Max. DC Power (W)	9800	11200	12600	14000
Max. DC Voltage (V)			600	
MPPT Voltage Range (V)			70-550	
MPPT Full Power Voltage Range (V)			220-550	
Rated Input Voltage (V)			360	
Start-up Voltage (V)			70	
Max. Input Current (A)		14+26		26+26
Max. Short Current (A)		18+35		35+35
No. of MPP Tracker / No. of PV String		2/3		2/4
Input Connector Type			MC4	
AC Output Data	HNS7000TL	HNS8000TL	HNS9000TL	HNS10000TL
Max. Output Power (W)	7700	8800	9900	11000
Nominal Output Power (W)	7000	8000	9000	10000
Max. Output Current (A)	33.6	38.3	45	50
Nominal Output Voltage (V)		L/N/PE, 220Vac, 230Vac, 240Vac		
Grid Voltage Range		180Vac-276Vac (According to local standard)		
Nominal Output Frequency (Hz)		50/60		
Grid Frequency Range		45-55Hz/54-66Hz (According to local standard)		
Output Power Factor		1 default (adjustable from 0.8 leading to 0.8 lagging)		
Output Current THD		<3%		
Efficiency	HNS7000TL	HNS8000TL	HNS9000TL	HNS10000TL
Max. Efficiency	98.20%	98.20%	98.32%	98.40%
Euro Efficiency	97.95%	98.00%	98.00%	98.10%
Protection	HNS7000TL	HNS8000TL	HNS9000TL	HNS10000TL
PV Reverse Polarity Protection			YES	
PV Insulation Resistance Detection			YES	
AC Short Circuit Protection			YES	
AC Over Current Protection			YES	
AC Over Voltage Protection			YES	
Anti-Islanding Protection			YES	
Residual Current Detection			YES	
Over Temperature Protection			YES	
Integrated DC switch			YES	
Surge Protection		Integrated (Type III)		
Smart IV Curve Scanning			YES	
Quick Arc Fault Circuit Interruption		Optional		
General Data	HNS7000TL	HNS8000TL	HNS9000TL	HNS10000TL
Dimensions (H x W x D, mm)	510 x 370 x 167		527 x 370 x 188	
Weight (kg)	17		19	
Protection Degree		IP65		
Enclosure Material		Aluminum		
Ambient Temperature Range (°C)		-25 - +60		
Humidity Range		0-100%		
Topology		Transformerless		
Communication Interface		RS485 / WiFi / Wire Ethernet / GPRS (optional)		
Cooling Concept		Convection		
Noise Emission (db)		<40		
Night Power Consumption (W)		<1		
Max. Operation Altitude (m)		4000		
Certifications and Standards	HNS7000TL	HNS8000TL	HNS9000TL	HNS10000TL
EMC Standard	EN/IEC 61000-6-2, EN/IEC 61000-6-3, EN61000-3-2, EN61000-3-3, EN61000-3-11, EN61000-3-12			
Safety Standard	IEC 60068, UL1741, EN62109			
Grid-connection	IEEE1547, CSA C22, EN50549, VDE4105, VDE0126, RD1699, ABNT NBR16149 & 16150, AS4777.2, NB/T32004, G98/G99, IEC61727			